



LED Indicators

Stack Lights with LEDs

Series TWR

Series TWR

Technical features

Body material: **Polycarbonate (PC) V0/UL 94**
 Body colour: **Black**
 Lens: **Polycarbonate**
 Protection degree: **IP65**
NEMA 4X
 Working temperature: **-20°C +60°C**
 Operating life at AT 25°C: **100.000 h**
LEDs not replaceable
Modules not detachable



Integrated Rectifier Bridge to work in Alternating Current (AC) or Direct Current (DC), automatically.

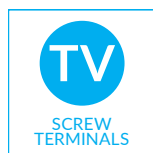

Easy to connect thanks to the Screw terminals or Flying Leads.

Customs tariff: **85389091**

Supply voltage +/- 10%

Power	Consumption	Current
24 Vac/dc	15-20mA	AC/DC
48 Vac/dc	15-20mA	AC/DC
130 = 110-130 Vac/dc (Not available for all versions)	15-20mA	AC/DC
240 Vac (Not available for all versions)	15mA	Alternating Current
220 Vdc (Not available for all versions)	9mA	Direct Current

Other power supplies on request



Tropicalization treatment available on request.

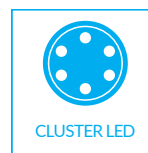
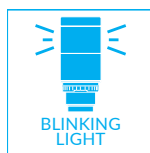

Optional Blinking Light. Extra bright visibility even with sunlight thanks to the powerful Cluster LED.

Compliance:

Directive 2006/95/EC Low Voltage

Directive 2004/108/EC Electromagnetic Compatibility

Directive 2011/65/EC RhOS

Directive 2006/42/EC Machinery

Conformity to standards:

EN 60947.5.1 / EN 60073 / EN 60529 / EN 60068-2-6 /

EN 60204.1 / EN ISO 7731 / EN 981 / IEC 536

DOMO reserves the right to change, amend, modify, suspend, continue or terminate all or any part of the Product range either in an individual case or in general, at any time without notice.

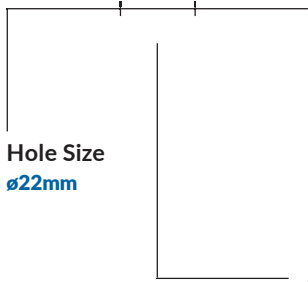
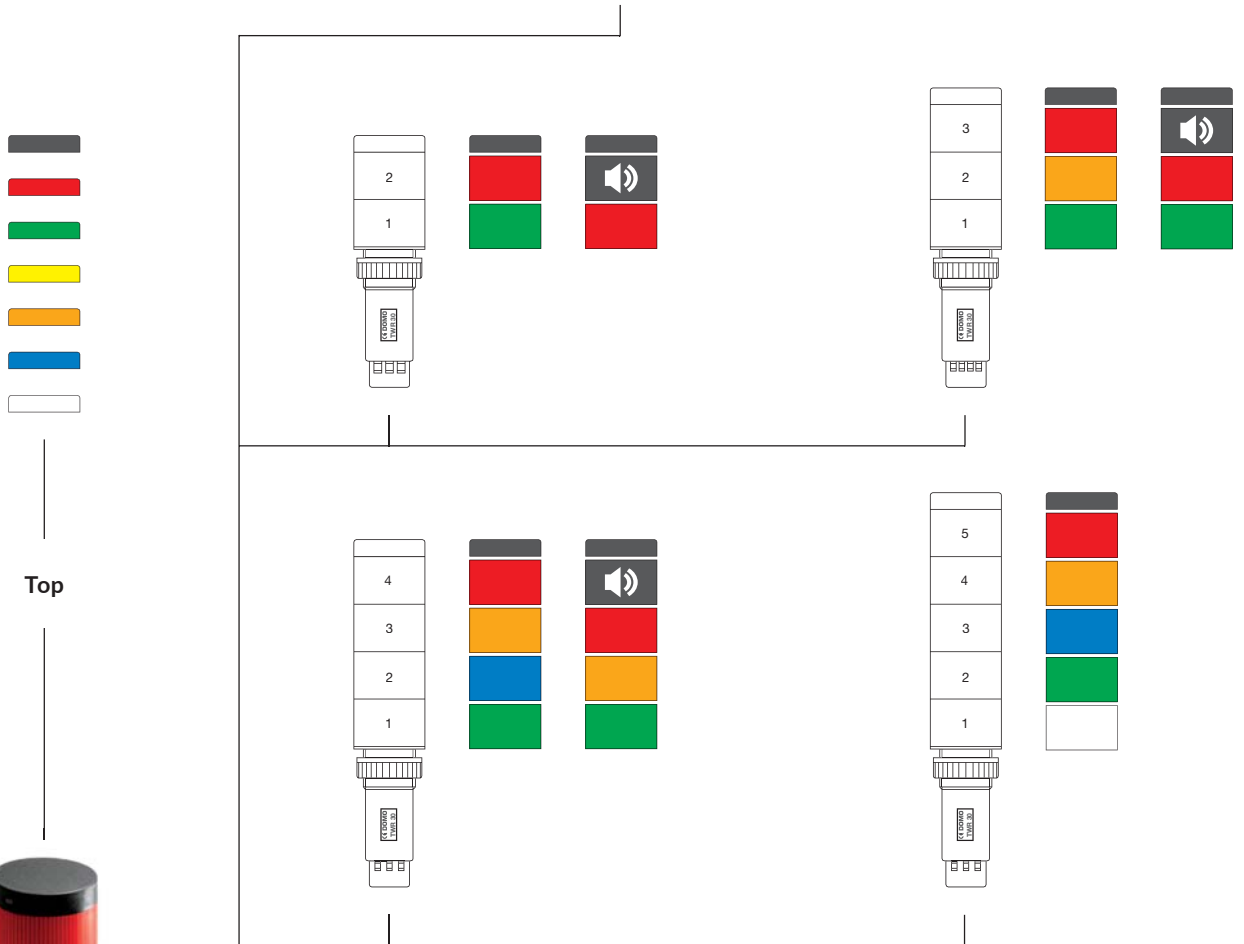
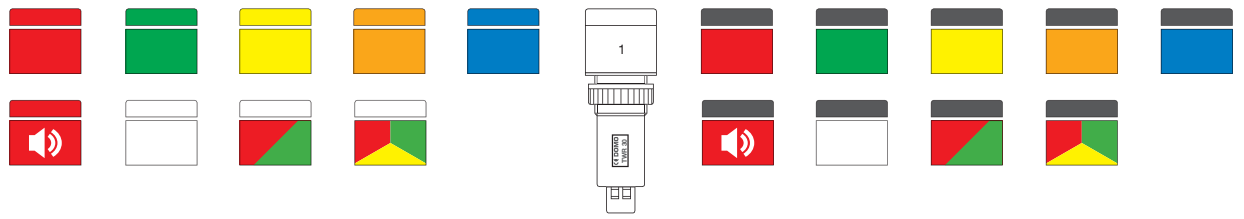

Connections
SCREW terminals
FLYING LEADS

Accessories

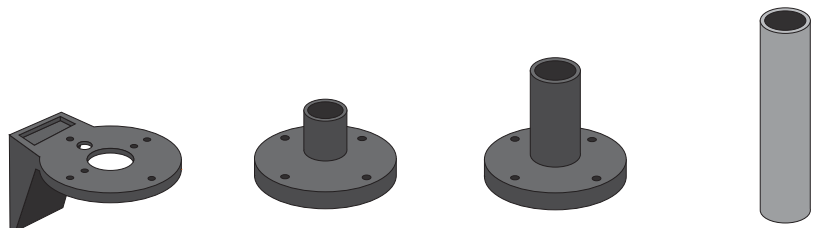

Series TWR - ø22mm

Coding

Mono-Stack Light / One Module Stack Light

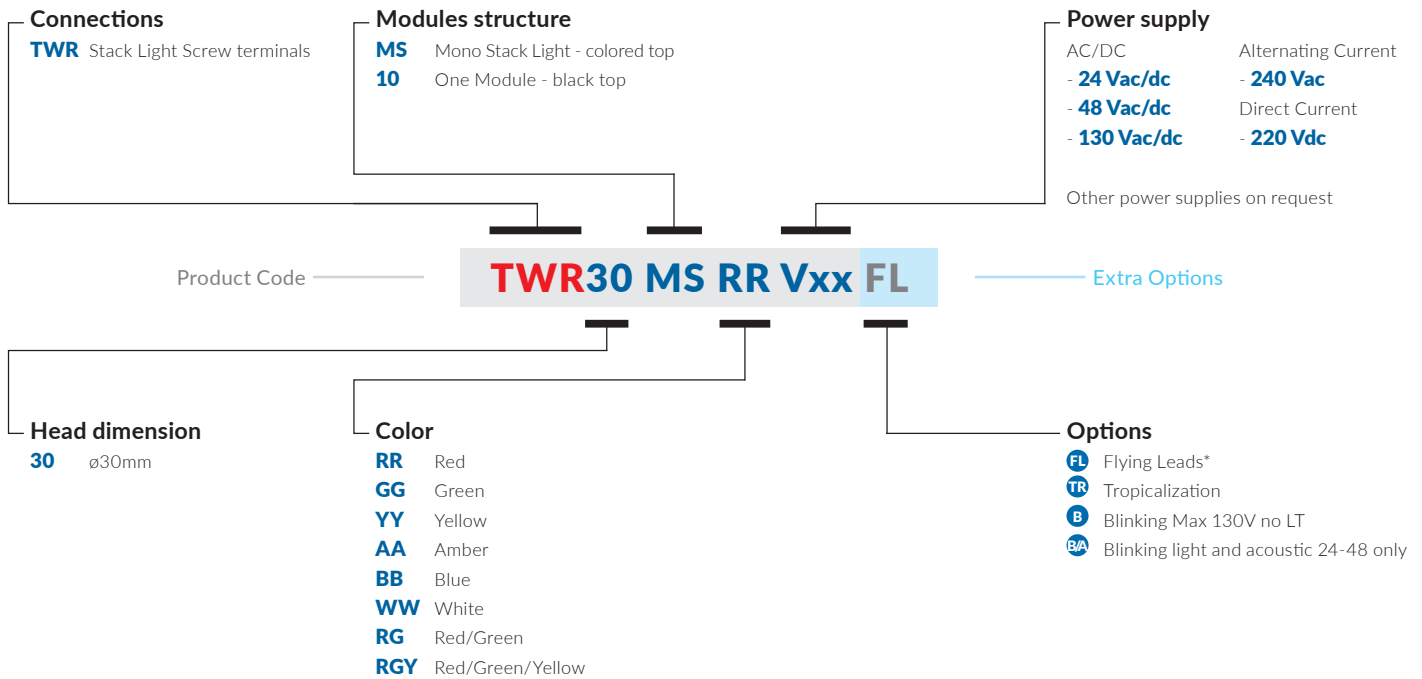

Multi Modules Stack Light preassembled

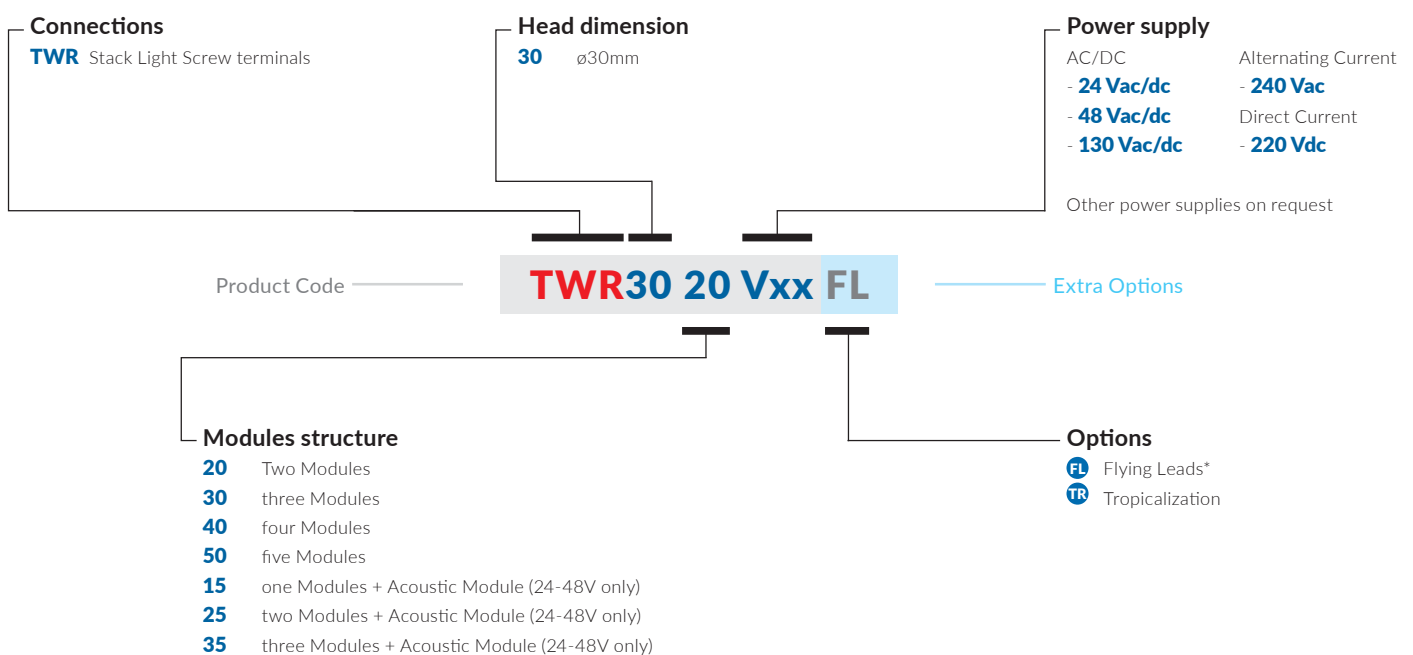

Please see product range section for the feasibility. Special version on request.

* Please contact our sales office to define details.



TWR30 MS
Head Ø30mm
Cut-out Ø22
Weight 20g

TWR30
Head Ø30mm
Cut-out Ø22
Weight 20g



Colors

LED diffuser

LED

● Red

● Green

● Yellow

● Amber

● Blue

○ White

● Red

● Green

● Yellow

● Amber

● Blue

○ White

TWR30 MS RR Vxx

TWR30 MS GG Vxx

TWR30 MS YY Vxx

TWR30 MS AA Vxx

TWR30 MS BB Vxx

TWR30 MS WW Vxx

TWR30 10 RR Vxx

TWR30 10 GG Vxx

TWR30 10 YY Vxx

TWR30 10 AA Vxx

TWR30 10 BB Vxx

TWR30 10 WW Vxx

FL TR B Max 130V BA 24-48V only

FL TR B Max 130V BA 24-48V only

Bicolor, Tricolor

○ White

○ White

● Red/Green

● Red/Green/Yellow

TWR30 MS RG Vxx

TWR30 MS RGY Vxx

TWR30 10 RG Vxx

TWR30 10 RGY Vxx

FL TR

FL TR

Series TWR - ø22mm

Product range

preassembled

TWR30
Head Ø30mm
Cut-out Ø22
Weight 30g



Module 2 ● Red
Module 1 ● Green

TWR30 20 Vxx



TWR30
Head Ø30mm
Cut-out Ø22
Weight 40g



Module 3 ● Red
Module 2 ● Amber
Module 1 ● Green

TWR30 30 Vxx



TWR30
Head Ø30mm
Cut-out Ø22
Weight 50g



Module 4 ● Red
Module 3 ● Amber
Module 2 ● Blue
Module 1 ● Green

TWR30 40 Vxx

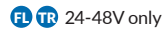

TWR30
Head Ø30mm
Cut-out Ø22
Weight 60g



Module 5 ● Red
Module 4 ● Amber
Module 3 ● Blue
Module 2 ● Green
Module 1 ○ White

TWR30 50 Vxx

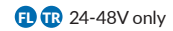

TWR30
Head Ø30mm
Cut-out Ø22
Weight 31g



Module 2 Acoustic
Module 1 ● Red

TWR30 15 Vxx



TWR30
Head Ø30mm
Cut-out Ø22
Weight 41g



Module 3 Acoustic
Module 2 ● Red
Module 1 ● Green

TWR30 25 Vxx

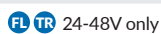

TWR30
Head Ø30mm
Cut-out Ø22
Weight 51g



Module 4 Acoustic
Module 3 ● Red
Module 2 ● Amber
Module 1 ● Green

TWR30 35 Vxx



Modules + Acoustic Module



TWR30 MS

Dimensions mm 1:2

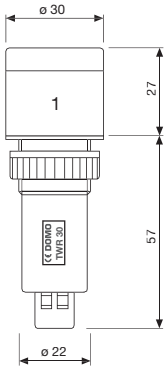

TWR30 - 1 mod.

Dimensions mm 1:2

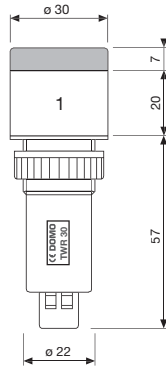

TWR30 - 2 mod.

Dimensions mm 1:2

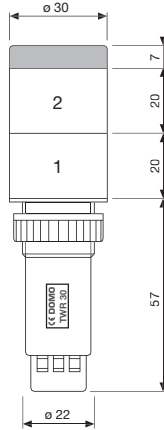

TWR30 - 3 mod.

Dimensions mm 1:2

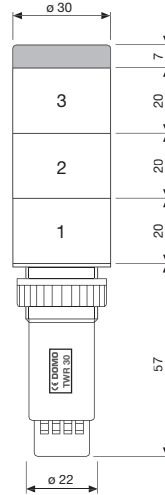

TWR30 - 4 mod.

Dimensions mm 1:2

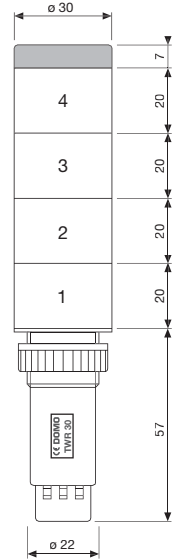

Screw terminal 14 AWG 2,5mmq

Monocolor

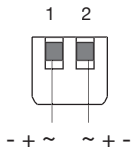

1 Module

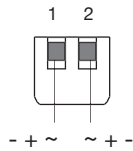

2 Modules

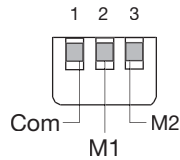

Screw terminal 16 AWG 0,75 ÷ 1,0mmq

3 Modules

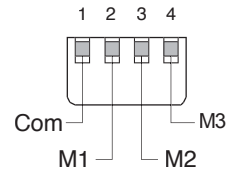

4 Modules

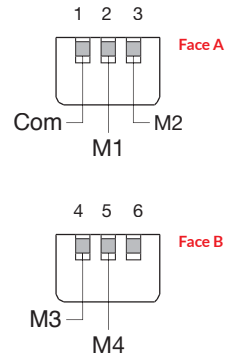

Flying Leads

Monocolor

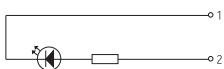

1 Module

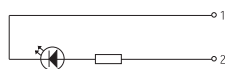

2 Modules

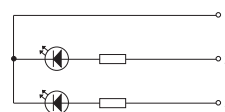

3 Modules

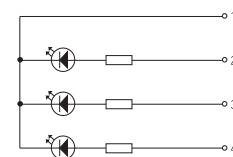

4 Modules

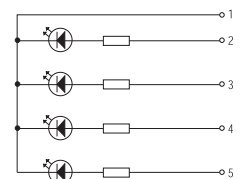

1 - White
2 - Brown

1 - White
2 - Brown

1 - White
2 - Brown
3 - Green

1 - White
2 - Brown
3 - Green
4 - Yellow

1 - White
2 - Brown
3 - Green
4 - Yellow
5 - Grey

Series TWR - ø22mm

Dimensions and wiring

TWR30 - 5 mod.

Dimensions mm 1:2

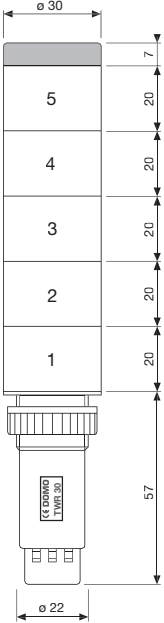

TWR30 - 1 mod. + Ac.

Dimensions mm 1:2

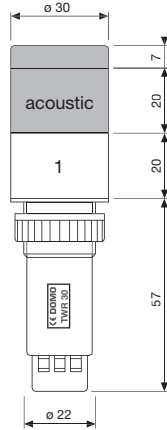

TWR30 - 2 mod. + Ac.

Dimensions mm 1:2

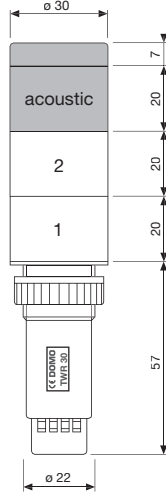

TWR30 - 3 mod. + Ac.

Dimensions mm 1:2

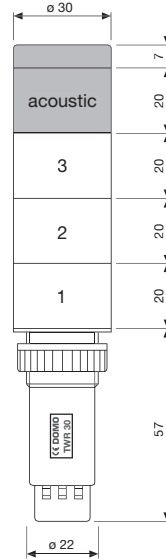

Screw terminal
14 AWG 2,5mmq

Screw terminal
16 AWG 0,75 ÷ 1,0mmq

5 Modules

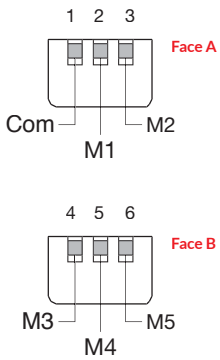

1 Mod. + Acoustic Mod.

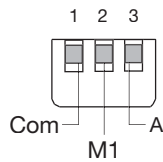

2 Mod. + Acoustic Mod.

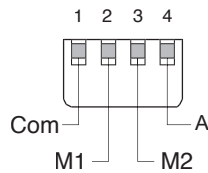

3 Mod. + Acoustic Mod.

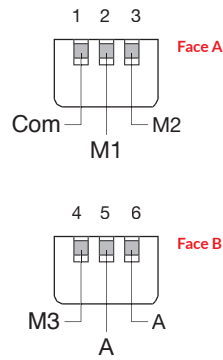

5 Modules

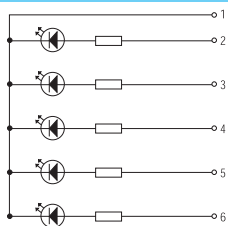

- 1 - White
- 2 - Brown
- 3 - Green
- 4 - Yellow
- 5 - Grey
- 6 - Pink

1 Mod. + Acoustic Mod.

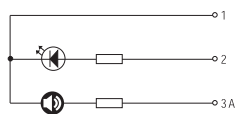

- 1 - White
- 2 - Brown
- 3 - Green

2 Mod. + Acoustic Mod.

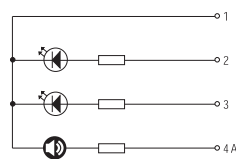

- 1 - White
- 2 - Brown
- 3 - Green
- 4 - Yellow

3 Mod. + Acoustic Mod.

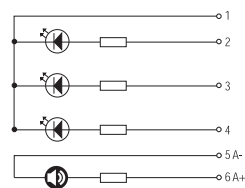

- 1 - White
- 2 - Brown
- 3 - Green
- 4 - Yellow
- 5 - Grey
- 6 - Pink



Wall mounting bracket for
 • $\varnothing 22\text{mm}$ indicators
 • base for tube
 • base for $\varnothing 22\text{mm}$ indicators
 Weight 19g



ABR 70 1

Base for $\varnothing 26\text{mm}$ tube
 Weight 19g



ABS70 TB

$\varnothing 26\text{mm}$ aluminium tube,
 for $\varnothing 22\text{mm}$ indicators
 Length to be specified



ABS70 TR22 X

Base for $\varnothing 22\text{mm}$ indicators
 Weight 21g



ABS70 22D

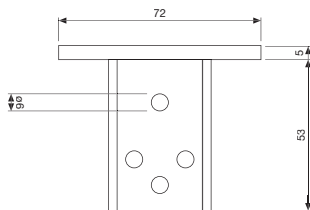
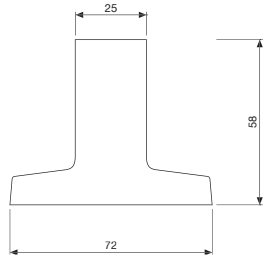
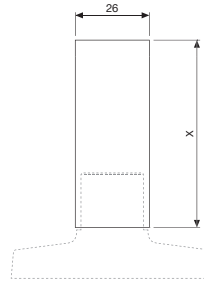
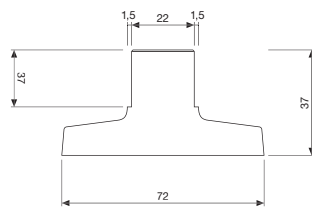
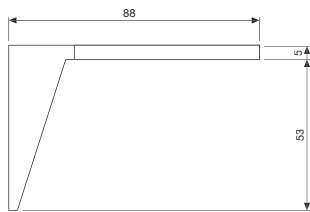
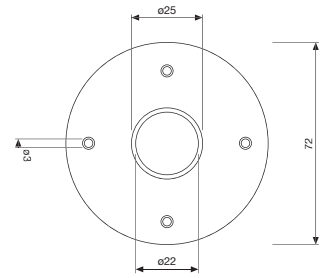
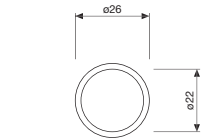
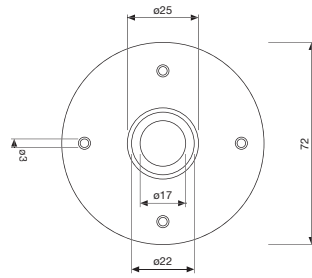
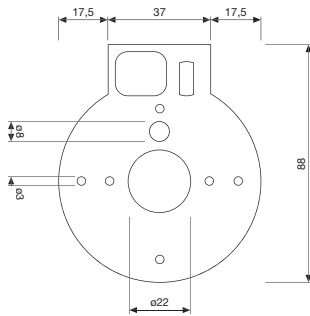

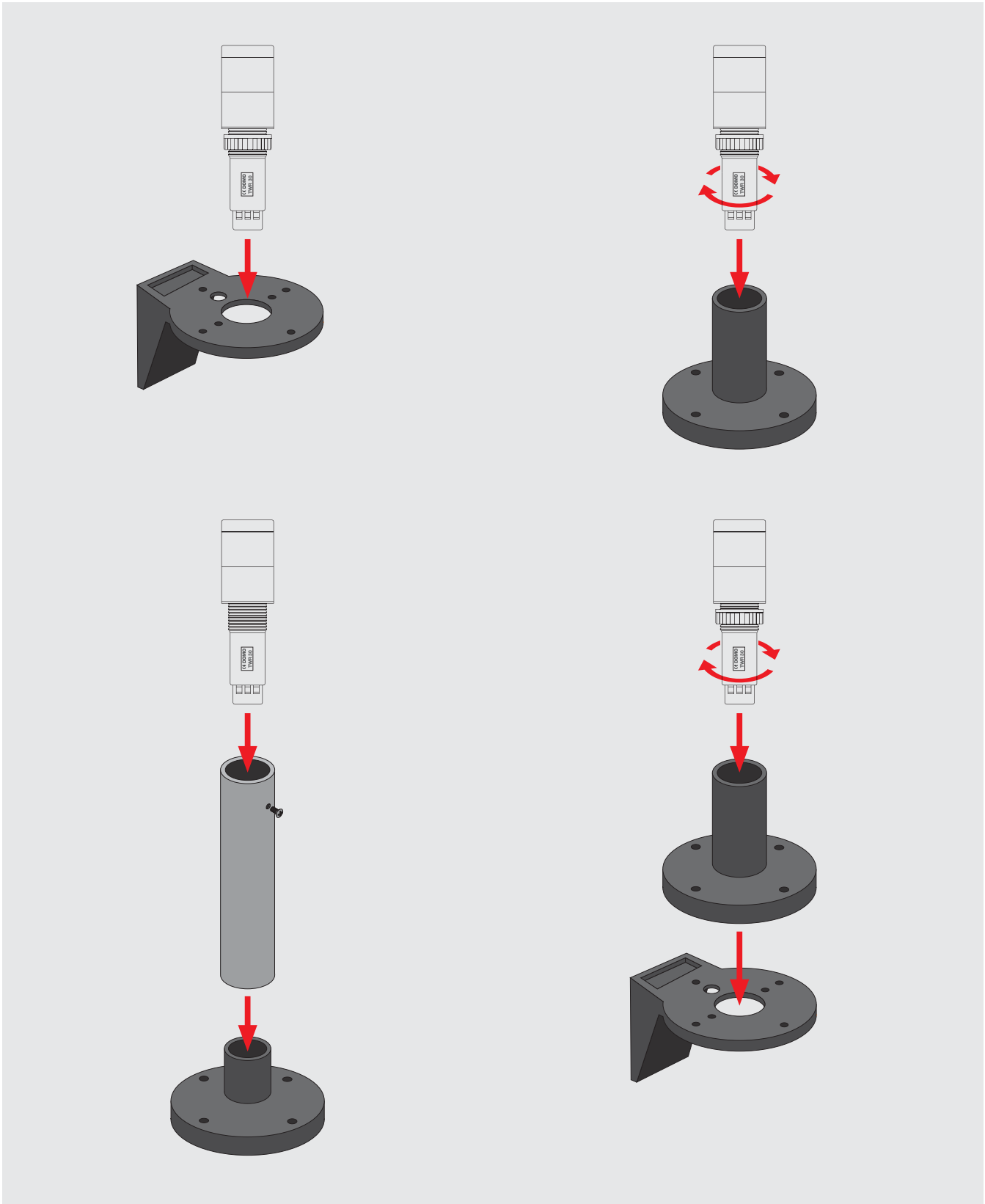

Attention! Screw and plastic ring protection included.

Accessories and spare parts Ø22mm

Round label holder
Weight 2g



SIM22/30 PTR

Square label holder
Weight 2g



SIM22/30 PTS

Fastener for type B elements
Weight 3g



ASB 30

Reducer ring from ø30mm to ø22mm
Weight 2g



ARF 30/22

Labels
Weight 4g



SIM22/30 TOW

Protective slides
Weight 4g



SIM22/30 VPK

Tightening wrench
Weight 9g



ACK 22/16

Lamp extractor
Weight 2g

Compatible with:
BA9s, BA7s, T5.5, T5.5k, MG



AEL BA9s/T5.5

Comparative table



Series	SFT	SLT	CR	PI	ML	VEB	PHR	
	Sferical	Sferical	Semaphore	Position	Multiled	Extrabright	Beacon	
Page	12	12	26	26	50	64	74	
Function								
Indicator	•	•	•	•	•	•	•	
Buzzer								
Pushbutton								
double pushbutton								
illuminated pushbutton								
Emergency mushroom								
Keylock switch								
selector switch								
Emergency for safety								
Design								
Protruding	•	•	•	•	•	•	•	
Flushmounting			•	•				
Round	•	•	•	•	•	•	•	
Square			•	•	•			
Rectangular								
Front protection (internal test)								
IP40					•			
IP54	•	•	•	•	•		•	
IP65					•	•		
IP67								
Contact rating								
10A								
5A								
Mounting Cut-out								
Ø8								
Ø12								
Ø16	•		•	•		•	•	
Ø22	•	•	•	•	•	•	•	
Terminal								
Faston 2,8x0,8	•	•	•	•	•	•	•	
Faston 2,8x0,5								
Screw	•	•	•	•	•	•	•	
Push-in (future)	F	F	F	F	F	F	F	
BA9s, Ba7s, E10, MG, BA15d, BA15s, E14								
Marking								
Paint, Engraving, Film insert				•	•			
Option								
Lamp Test (LT)	•	•	•	•	•			
Inbuilt Diode to avoid reverse feeding (PD)	•	•	•	•	•			
Tropicalization (TR)	•	•	•	•	•	•	•	
Double input + double lamp test (2C+2LT)			•					
Low voltage glow protection (LVGP)	F	F	F	F	F	F	F	
RGB color		•						
Compatible for DOMO Mosaic Mimic								
Protruding	•	•	•	•	•	•	•	
Flushmounting			•	•	•			

F = Future

